

Lecture 21

Cavity Resonators

Cavity resonators are important components of microwave and optical systems. They work by constructive and destructive interference of waves in an enclosed region. They can be used as filters, or as devices to enhance certain physical interactions. These can be radiation antennas or electromagnetic sources such as magnetrons or lasers. They can also be used to enhance the sensitivity of sensors. We will study a number of them, and some of them, only heuristically in this lecture.

21.1 Transmission Line Model of a Resonator

The simplest cavity resonator is formed by using a transmission line. The source end can be terminated by Z_S and the load end can be terminated by Z_L . When Z_S and Z_L are non-dissipative, such as when they are reactive loads (capacitive or inductive), then no energy is dissipated as a wave is reflected off them. Therefore, if the wave can bounce and interfere constructively between the two ends, a coherent solution or a resonant solution can exist due to constructive interference.

The resonant solution exists even when the source is turned off. In mathematical parlance, this is a homogeneous solution to a partial differential equation or ordinary differential equation, since the right-hand side of the pertinent equation is zero. The right-hand side of these equations usually corresponds to a source term or a driving term. In physics parlance, this is a natural solution since it exists naturally without the need for a driving or exciting source.

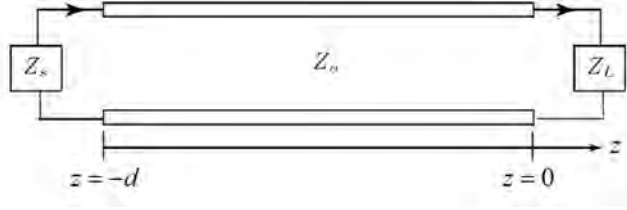

Figure 21.1: A simple resonator can be made by terminating a transmission line with two reactive loads at its two ends, the source end with Z_S and the load end with Z_L .

The transverse resonance condition for 1D problem can be used to derive the resonance condition, namely that

$$1 = \Gamma_S \Gamma_L e^{-2j\beta_z d} \quad (21.1.1)$$

where Γ_S and Γ_L are the reflection coefficients at the source and the load ends, respectively, β_z the wave number of the wave traveling in the z direction, and d is the length of the transmission line. For a TEM mode in the transmission line, as in a coax filled with homogeneous medium, then $\beta_z = \beta$, where β is the wavenumber for the homogeneous medium. Otherwise, for a quasi-TEM mode, $\beta_z = \beta_e$ where β_e is some effective wavenumber for a z -propagating wave in a mixed medium. In general,

$$\beta_e = \omega/v_e \quad (21.1.2)$$

where v_e is the effective phase velocity of the wave in the heterogeneous structure.

When the source and load impedances are replaced by short or open circuits, then the reflection coefficients are -1 for a short, and $+1$ for an open circuit. The (21.1.1) above then becomes

$$\pm 1 = e^{-2j\beta_e d} \quad (21.1.3)$$

The \pm sign corresponds to different combinations of open and short circuits at the two ends of the transmission lines. When a “+” sign is chosen, which corresponds to either both ends are short circuit, or are open circuit, the resonance condition is such that

$$\beta_e d = p\pi, \quad p = 0, 1, 2, \dots, \quad \text{or integer} \quad (21.1.4)$$

For a TEM or a quasi-TEM mode in a transmission line, $p = 0$ is not allowed as the voltage will be uniformly zero on the transmission line or $V(z) = 0$ for all z implying a trivial solution. The lowest mode then is when $p = 1$ corresponding to a half wavelength on the transmission line.

When the line is open at one end, and shorted at the other end in (21.1.1), the resonance condition corresponds to the “-” sign in (21.1.3), which gives rise to

$$\beta_e d = p\pi/2, \quad p \quad \text{odd} \quad (21.1.5)$$

The lowest mode is when $p = 1$ corresponding to a quarter wavelength on the transmission line, which is smaller than that of a transmission line terminated with short or open at both ends. Designing a small resonator is a prerogative in modern day electronic design. For example, miniaturization in cell phones calls for smaller components that can be packed into smaller spaces.

A quarter wavelength resonator made with a coax is shown in Figure 21.2. It is easier to make a short indicated at the left end, but it is hard to make a true open circuit as shown at the right end. A true open circuit means that the current has to be zero. But when a coax is terminated with an open, the electric current does not end abruptly. The fringing field at the right end gives rise to stray capacitance through which displacement current can flow in accordance to the generalized Ampere's law. Hence, we have to model the right end termination with a small stray or fringing field capacitance as shown in Figure 21.2. This indicates that the current does not abruptly go to zero at the right-hand side due to the presence of fringing field and hence, displacement current.

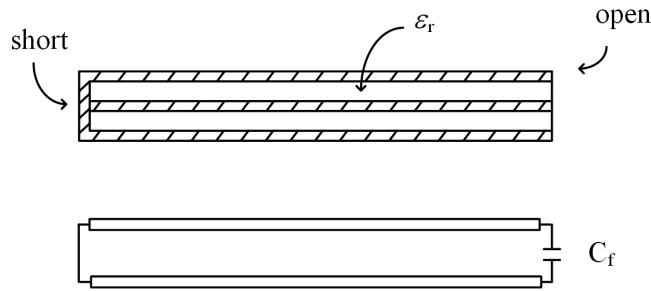

Figure 21.2: A short and open circuited transmission line can be a resonator, but the open end has to be modeled with a fringing field capacitance C_f since there is no exact open circuit.

21.2 Cylindrical Waveguide Resonators

Since a cylindrical waveguide¹ is homomorphic to a transmission line, we can model a mode in this waveguide as a transmission line. Then the termination of the waveguide with either a short or an open circuit at its end makes it into a resonator.

Again, there is no true open circuit in an open ended waveguide, as there will be fringing fields at its open ends. If the aperture is large enough, the open end of the waveguide radiates and may be used as an antenna as shown in Figure 21.3.

¹Both rectangular and circular waveguides are cylindrical waveguides.



Figure 21.3: A rectangular waveguide terminated with a short at one end, and an open circuit at the other end. The open end can also act as an antenna as it also radiates (courtesy of RFcurrent.com).

As previously shown, single-section waveguide resonators can be modeled with a transmission line using homomorphism with the appropriately chosen β_z . Then, $\beta_z = \sqrt{\beta^2 - \beta_s^2}$ where β_s can be found by first solving a 2D waveguide problem corresponding to the reduced-wave equation.

For a rectangular waveguide, for example, from previous lecture,

$$\beta_z = \sqrt{\beta^2 - \left(\frac{m\pi}{a}\right)^2 - \left(\frac{n\pi}{b}\right)^2} \quad (21.2.1)$$

for both TE_{mn} and TM_{mn} modes.² If the waveguide is terminated with two shorts (which is easy to make) at its ends, then the resonance condition is that

$$\beta_z = p\pi/d, \quad p \text{ integer} \quad (21.2.2)$$

Together, using (21.2.1), we have the condition that

$$\beta^2 = \frac{\omega^2}{c^2} = \left(\frac{m\pi}{a}\right)^2 + \left(\frac{n\pi}{b}\right)^2 + \left(\frac{p\pi}{d}\right)^2 \quad (21.2.3)$$

The above can only be satisfied by certain select frequencies, and these frequencies are the resonant frequencies of the rectangular cavity. The corresponding mode is called the TE_{mnp} mode or the TM_{mnp} mode depending on if these modes are TE to z or TM to z .

²It is noted that for a certain mn mode, with a choice of frequency, $\beta_z = 0$ which does not happen in a transmission line.

The entire electromagnetic fields of the cavity can be found from the scalar potentials previously defined, namely that

$$\mathbf{E} = \nabla \times \hat{z}\Psi_h, \quad \mathbf{H} = \nabla \times \mathbf{E}/(-j\omega) \quad (21.2.4)$$

$$\mathbf{H} = \nabla \times \hat{z}\Psi_e, \quad \mathbf{E} = \nabla \times \mathbf{H}/(j\omega\varepsilon) \quad (21.2.5)$$

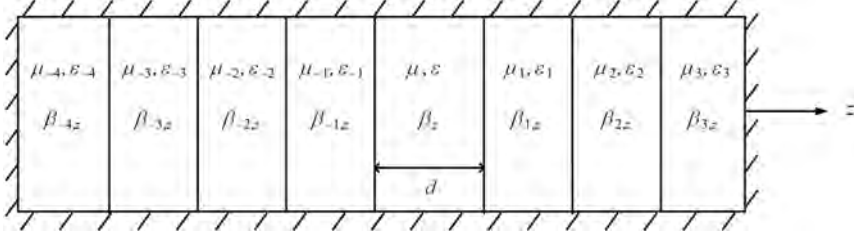

Figure 21.4: A waveguide filled with layered dielectrics can also become a resonator. The transverse resonance condition can be used to find the resonant modes.

Since the layered medium problem in a waveguide is the same as the layered medium problem in open space, we can use the generalized transverse resonance condition to find the resonant modes of a waveguide cavity loaded with layered medium as shown in Figure 21.4. This condition is repeated below as:

$$\tilde{R}_- \tilde{R}_+ e^{-2j\beta_z d} = 1 \quad (21.2.6)$$

where d is the length of the waveguide section where the above is applied, and \tilde{R}_- and \tilde{R}_+ are the generalized reflection coefficient to the left and right of the center waveguide section. The above is similar to the resonant condition using the transmission line model in (21.1.1), except that now, we have replaced the transmission line reflection coefficient with TE or TM generalized reflection coefficients.

21.2.1 $\beta_z = 0$ Case

In this case, we can still look at the TE and the TM modes in the waveguide. This corresponds to a waveguide mode that bounces off the waveguide wall, but make no progress in the z direction. The modes are independent of z since $\beta_z = 0$. It is quite easy to show that for the TE case, a z -independent $\mathbf{H} = \hat{z}H_0$, and $\mathbf{E} = \mathbf{E}_s$ exist inside the waveguide, and for the TM case, a z -independent $\mathbf{E} = \hat{z}E_0$, and $\mathbf{H} = \mathbf{H}_s$ being the only components in the waveguide.

Consider now a single section waveguide. For the TE mode, if either one of the ends of the waveguide is terminated with a PEC wall, then $\hat{n} \cdot \mathbf{H} = 0$ at the end. This will force the z -independent \mathbf{H} field to be zero in the entire waveguide. Thus for the TE mode, it can only exist if both ends are terminated with open, but this mode is not trapped inside since it easily leaks energy to the outside via the ends of the waveguide.

For the TM mode, since $\mathbf{E} = \hat{z}E_0$, it easily satisfy the boundary condition if both ends are terminated with PEC walls since the boundary condition is that $\hat{n} \times \mathbf{E} = 0$. The wonderful part about this mode is that the length or d of the cavity can be as short as possible.

21.2.2 Lowest Mode of a Rectangular Cavity

The lowest TM mode in a rectangular waveguide is the TM_{11} mode. At the cutoff of this mode, the $\beta_z = 0$ or $p = 0$, implying no variation of the field in the z direction. When the two ends are terminated with metallic shorts, the tangential magnetic field is not shorted out. But the tangential electric field is shorted to zero in the entire cavity, or that the TE mode cannot exist. Therefore, the longitudinal electric field of the TM mode still exists (see Figures 21.5 and 21.6). As such, for the TM mode, $m = 1$, $n = 1$ and $p = 0$ is possible giving a non-zero field in the cavity. This is the TM_{110} mode of the resonant cavity, which is the lowest mode in the cavity if $a > b > d$. The top and side views of the fields of this mode is shown in Figures 21.5 and 21.6. The corresponding resonant frequency of this mode satisfies the equation

$$\frac{\omega_{110}^2}{c^2} = \left(\frac{\pi}{a}\right)^2 + \left(\frac{\pi}{b}\right)^2 \quad (21.2.7)$$

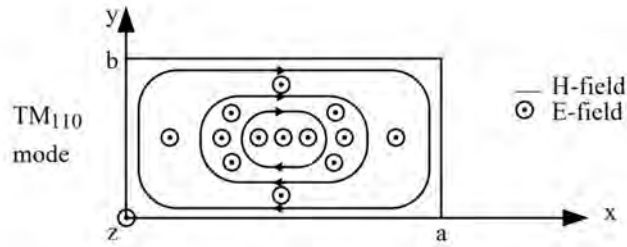

Figure 21.5: The top view of the E and H fields of a rectangular resonant cavity.

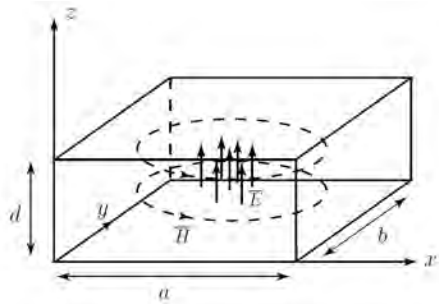

Figure 21.6: The side view of the E and H fields of a rectangular resonant cavity (courtesy of J.A. Kong [32]).

For the TE modes, it is required that $p \neq 0$, otherwise, the field is zero in the cavity. For example, it is possible to have the TE_{101} mode with nonzero \mathbf{E} field. The resonant frequency

of this mode is

$$\frac{\omega_{101}^2}{c^2} = \left(\frac{\pi}{a}\right)^2 + \left(\frac{\pi}{d}\right)^2 \quad (21.2.8)$$

Clearly, this mode has a higher resonant frequency compared to the TM_{110} mode if $d < b$.

The above analysis can be applied to circular and other cylindrical waveguides with β_s determined differently. For instance, for a circular waveguide, β_s is determined differently using Bessel functions, and for a general arbitrarily shaped waveguide, β_s may have to be determined numerically.

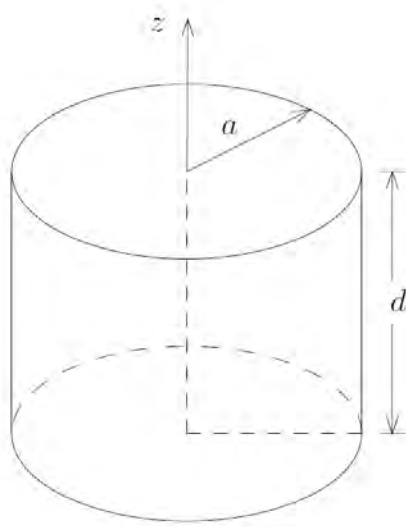

Figure 21.7: A circular resonant cavity made by terminating a circular waveguide (courtesy of Kong [32]).

For a spherical cavity, one would have to analyze the problem in spherical coordinates. The equations will have to be solved by the separation of variables using spherical harmonics. Details are given on p. 468 of Kong [32].

21.3 Some Applications of Resonators

Resonators in microwaves and optics can be used for designing filters, energy trapping devices, and antennas. As filters, they are used like LC resonators in circuit theory. A concatenation of them can be used to narrow or broaden the bandwidth of a filter. As an energy trapping device, a resonator can build up a strong field inside the cavity if it is excited with energy close to its resonance frequency. They can be used in klystrons and magnetrons as microwave sources, a laser cavity for optical sources, or as a wavemeter to measure the frequency of

the electromagnetic field at microwave frequencies. An antenna is a radiator that we will discuss more fully later. The use of a resonator can help in resonance tunneling to enhance the radiation efficiency of an antenna.

21.3.1 Filters

Microstrip line resonators are often used to make filters. Transmission lines are often used to model microstrip lines in a microwave integrated circuits (MIC) or monolithic MIC (MMIC). In these circuits, due to the etching process, it is a lot easier to make an open circuit rather than a short circuit. But a true open circuit is hard to make as an open ended microstrip line has fringing field at its end as shown in Figure 21.8 [124, 125]. The fringing field gives rise to fringing field capacitance as shown in Figure 21.2. Then the appropriate Γ_S and Γ_L can be used to model the effect of fringing field capacitance. Figure 21.9 shows a concatenation of several microstrip resonators to make a microstrip filter. This is like using a concatenation of LC tank circuits to design filters in circuit theory.

Optical filters can be made with optical etalon as in a Fabry-Perot resonator, or concatenation of them. This is shown in Figure 21.10.

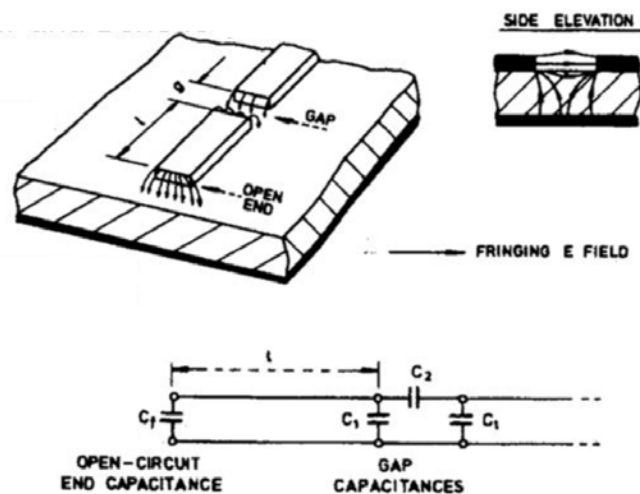

Figure 21.8: End effects and junction effects in a microwave integrated circuit [124, 125] (courtesy of Microwave Journal).

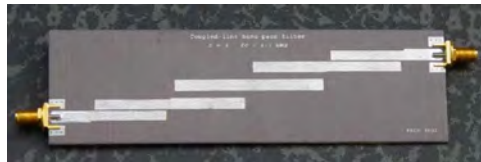

Figure 21.9: A microstrip filter designed using concatenated resonators. The connectors to the coax cable are the SMA (sub-miniature type A) connectors (courtesy of aginas.fe.up.pt).

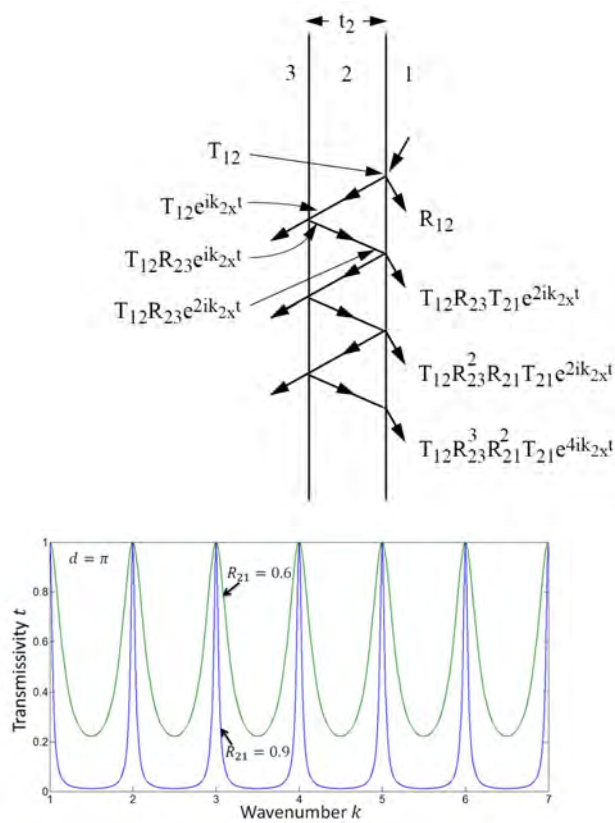

Figure 21.10: Design of a Fabry-Perot resonator [56, 83, 126, 127].

21.3.2 Electromagnetic Sources

Microwave sources are often made by transferring kinetic energy from an electron beam to microwave energy. Klystrons, magnetrons, and traveling wave tubes are such devices.

However, the cavity resonator in a klystron enhances the interaction of the electrons with the microwave field allowing for such energy transfer, causing the field to grow in amplitude as shown in Figure 21.11.

Magnetron cavity works also by transferring the kinetic energy of the electron into the microwave energy. By injecting hot electrons into the magnetron cavity, the electromagnetic cavity resonance is magnified by the absorbing kinetic energy from the hot electrons, giving rise to microwave energy.

Figure 21.13 shows laser cavity resonator to enhance of light wave interaction with material media. By using stimulated emission of electronic transition, light energy can be produced.

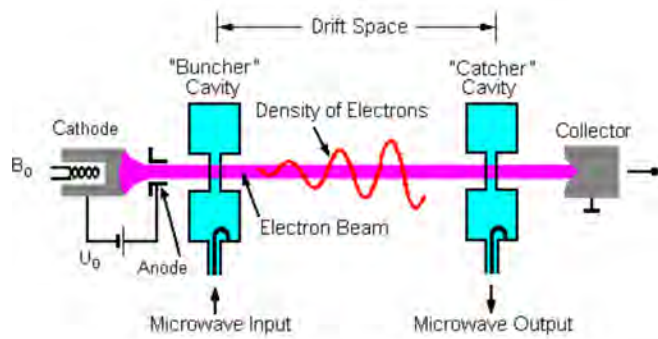

Figure 21.11: A klystron works by converting the kinetic energy of an electron beam into the energy of a traveling microwave next to the beam (courtesy of Wiki [128]).

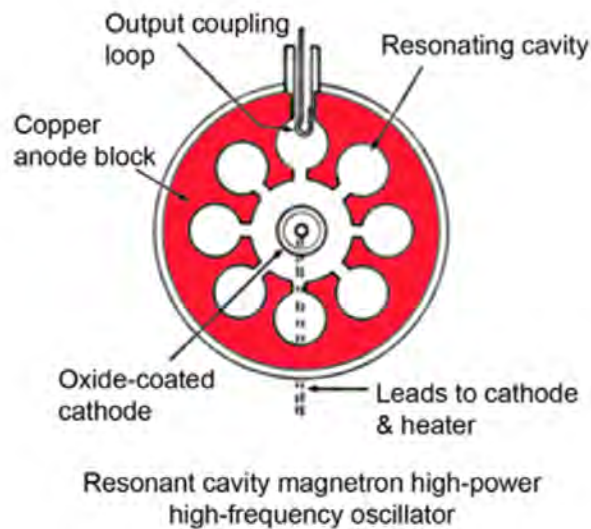

Figure 21.12: A magnetron works by having a high-Q microwave cavity resonator. When the cavity is injected with energetic electrons from the cathode to the anode, the kinetic energy of the electron feeds into the energy of the microwave (courtesy of Wiki [129]).

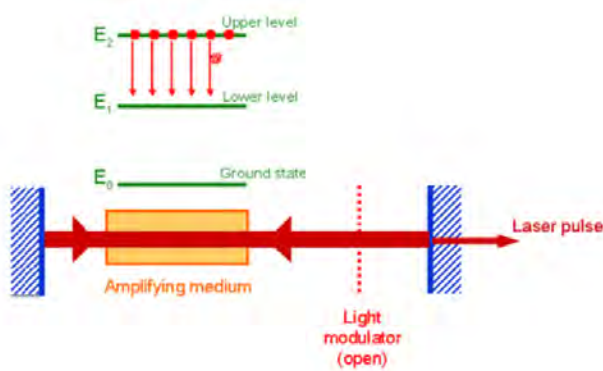

Figure 21.13: A simple view of the physical principle behind the working of the laser (courtesy of www.optique-ingenieur.org).

Energy trapping of a waveguide or a resonator can be used to enhance the efficiency of a semiconductor laser as shown in Figure 21.14. The trapping of the light energy by the heterojunctions as well as the index profile allows the light to interact more strongly with

the lasing medium or the active medium of the laser. This enables a semiconductor laser to work at room temperature. In 2000, Z. I. Alferov and H. Kroemer, together with J.S. Kilby, were awarded the Nobel Prize for information and communication technology. Alferov and Kroemer for the invention of room-temperature semiconductor laser, and Kilby for the invention of electronic integrated circuit (IC) or the chip.

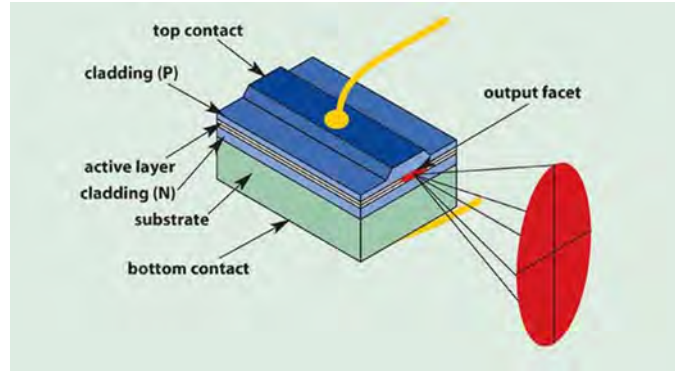

Figure 21.14: A semiconductor laser at work. Room temperature lasing is possible due to both the tight confinement of light and carriers (courtesy of Photonics.com).

21.3.3 Frequency Sensor

A cavity resonator can be used as a frequency sensor. It acts as an energy trap, because it will siphon off energy from a microwave when the microwave frequency hits the resonance frequency of the cavity resonator. This can be used to determine the frequency of the passing wave. Wavemeters are shown in Figures 21.15 and 21.16. As seen in the picture, there is an entry microwave port for injecting microwave into the cavity, and another exit port for the microwave to leave the cavity sensor. The passing microwave, when it hits the resonance frequency of the cavity, will create a large field inside it. The larger field will dissipate more energy on the cavity metallic wall, and gives rise to less energy leaving the cavity. This dip in energy transmission reveals the frequency of the microwave.



Figure 21.15: An absorption wave meter can be used to measure the frequency of microwave (courtesy of Wiki [130]).

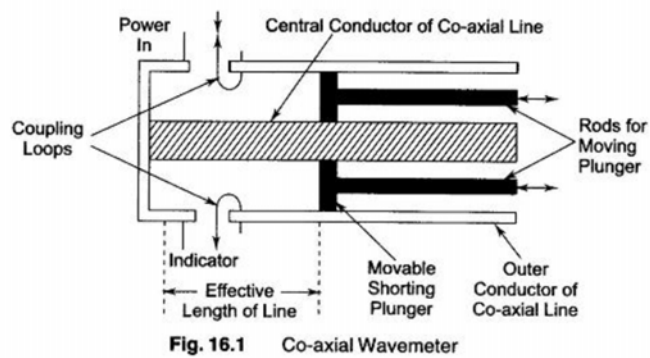

Fig. 16.1 Co-axial Wavemeter

Figure 21.16: The innards of a wavemeter (courtesy of eeeguide.com).

